



Konica Minolta bizhub C364e/C284e/C224e Specification & Installation Guide



KONICA MINOLTA

04/08/2013

bizhub C364e/C284e/C224e Specifications

Type	Full Color Printer/Copier/Scanner
Document holder	Stationary (mirror scanning)
Photoconductor	OPC
Luminous source	LED light-source illumination
Copying system	Laser electrostatic copy method
Developing system	Dry-2 component developing method
Fusing system	Belt Fusing
Resolution	Scanning: 600 x 600 dpi Printing: 1200 x 1200 dpi
Document holder	Types: Sheets, books (2-page spreads), three-dimensional objects Size: Maximum 11" x 17" Weight: 4.5 lb.
Paper	Thin Paper (14 lb. to 15.5 lb.)* Plain Paper (16 lb. to 24 lb.) Thick Paper 1 (24.25 lb. to 32 lb.) Thick Paper 1+ (32.25 lb. to 41.75 lb.) Thick Paper 2 (42 lb. to 55.5 lb.) Thick Paper 3 (55.75 lb. to 68 lb.) Thick Paper 4 (68.25 lb. to 79.75 lb.)** Recycled Paper (16 lb. to 24 lb.) Special Paper (16 lb. to 24 lb.) Letterhead (16 lb. to 24 lb.) Color Paper (16 lb. to 24 lb.) 1-Sided Special Paper (16 lb. to 24 lb.) Banner Paper** (34 lb. to 55.5 lb.) OHP Transparencies**, envelopes**, label sheets**, tabs**, postcards** *Cannot be fed through the bypass tray. **Can only be fed through the bypass tray; Monochrome copying/printing on transparencies is supported. Color copying/printing on transparencies is NOT supported.
Copy sizes	1st Tray: 11" x 17" to 8.5" x 11", 5.5" x 8.5", 8" x 13** 2nd Tray: 12.25" x 18" to 8.5" x 11", 5.5" x 8.5", 8" x 13** Bypass Tray: 12" x 18" to 5.5" x 8.5", 12.25" x 18", 4" x 6", 8" x 13**, Banner Paper *There are six Foolscap sizes: 220 x 330mm (☐), 8.5" x 13.5", 8.5" x 13" (☐), 8.25" x 13 (☐), 8.12" x 13.25" (☐) and 8" x 13" (☐). Any one of these sizes can be selected. For details, please consult with your authorized Konica Minolta Service representative.
Paper tray capacity	1st Tray and 2nd Tray: Thin Paper/Plain Paper/Recycled Paper/Special Paper/Letterhead/Color Paper/ 1-Sided Special Paper: 500 sheets; Thick Paper 1/1+/2/3: 150 sheets

Paper tray capacity (cont.)	Bypass Tray: Plain Paper/Recycled Paper/Special Paper/Letterhead/Color Paper/1-Sided Special Paper: 150 sheets; Thick Paper 1/1+/2/3/4/OHP Transparencies/Postcards/Tabs: 20 sheets; Envelopes: 10; Banner Paper/Label Sheets: 10 sheets																												
Copy exit tray capacity	Thin Paper: 100 sheets Plain Paper: 250 sheets Thick Paper: 10 sheets Overhead Projection Transparencies*: 1 sheet *Can only be fed through the bypass tray; Monochrome copying/printing on transparencies is supported. Color copying/printing on transparencies is NOT supported.																												
Warm-up time	Color and BW less than 20 seconds (at room temperature/73.4° F)																												
Image loss width	Leading edge: 0.1875" Trailing edge: 0.125" Rear edge: 0.125" Front edge: 0.125"																												
First copy	C364e: Color: 6.9 sec. or less B/W: 5.3 sec. or less C284e: Color: 7.7 sec. or less B/W: 5.9 sec or less C224e: Color: 8.3 sec. or less B/W: 6.9 sec or less																												
Print speed*: (Full Color/B&W) (Simplex/Duplex)	bizhub C364e: Plain paper: 36 sheets/min. Thick 1/Thick1+/Thick 2/Thick 3/Thick 4: 18 sheets/min. bizhub C284e: Plain paper: 28 sheets/min. Thick 1/Thick1+/Thick 2/Thick 3/Thick 4: 14 sheets/min. bizhub C224e: Plain paper: 22 sheets/min. Thick 1/Thick1+/Thick 2/Thick 3/Thick 4: 14 sheets/min.																												
Print speed (ppm)*:	Color/B&W (single sided/plain paper): <table border="1"> <thead> <tr> <th>Size</th> <th>C364e</th> <th>C284e</th> <th>C224e</th> </tr> </thead> <tbody> <tr> <td>11" x 17"</td> <td>18</td> <td>14</td> <td>14</td> </tr> <tr> <td>8.5" x 14"</td> <td>20</td> <td>16</td> <td>16</td> </tr> <tr> <td>8.5" x 11" ☐</td> <td>36</td> <td>28</td> <td>22</td> </tr> <tr> <td>8.5" x 11" ☐</td> <td>26</td> <td>20</td> <td>20</td> </tr> <tr> <td>5.5" x 8.5" ☐</td> <td>36</td> <td>28</td> <td>22</td> </tr> <tr> <td>8" x 13" ☐</td> <td>20</td> <td>16</td> <td>16</td> </tr> </tbody> </table> *Using 1st Tray	Size	C364e	C284e	C224e	11" x 17"	18	14	14	8.5" x 14"	20	16	16	8.5" x 11" ☐	36	28	22	8.5" x 11" ☐	26	20	20	5.5" x 8.5" ☐	36	28	22	8" x 13" ☐	20	16	16
Size	C364e	C284e	C224e																										
11" x 17"	18	14	14																										
8.5" x 14"	20	16	16																										
8.5" x 11" ☐	36	28	22																										
8.5" x 11" ☐	26	20	20																										
5.5" x 8.5" ☐	36	28	22																										
8" x 13" ☐	20	16	16																										

continued

Konica Minolta bizhub C364e/C284e/C224e

Specification & Installation Guide



bizhub C364e/C284e/C224e Specifications continued

Print speed (ppm)*:	Color/B&W (double sided/plain paper):
<small>continued</small>	Size
	C364e C284e C224e
	11" x 17" 18 14 14
	8.5" x 14" 20 16 16
	8.5" x 11" 36 28 22
	8.5" x 11" 25 20 20
	5.5" x 8.5" 36 28 22
	8" x 13" 20 16 16
	<small>*Using 1st Tray</small>
Magnification ratios	1.0 (full size: 1.00+_0.5% or less) Enlarge: 121.4%, 129.4%, 154.5%, 200% Reduce: 78.5%, 73.3%, 64.7%, 50.0% Minimal: 93% Stored Zoom Ratios: 3 "Minimal" zoom ratio (90% to 99.9%)
Multiple copies	1 to 9,999 sheets
Density control	Copy Density: Manual Density Adjustment (9 Levels); Background Density: Automatic and Manual Density Adjustments (9 levels)
Power requirements	120V, 12 A, 60 Hz
Power consumption	1.5 kW or less
TEC Value	C364e: 2.12 kWh C284e: 1.65 kWh C224e: 1.25 kWh
Dimensions (with control panel)	24.2" (W) x 27" (D) x 31" (H)
Space requirements*	36.9" (W) x 47.8" (D) x 30.7" (H)
Memory (available hard disk space)	2 GB, (250 GB HDD) (std); 2 GB (opt).
Weight	Approx. 185.18 lb.

* The indicated space requirements represent the space required to pull out the paper tray and the tray extension of the bypass tray and with the ADF open.

Duty Cycle

Up to **C364e:** 125,000, **C284e:** 100,000, **C224e:** 80,000.
Maximum monthly copy/print volume supported under standard vendor supplied service. Defines the upper end of the expected customer volume for the device. Customers should consider multiple machines if average monthly volume approaches duty cycle on continual basis.

Environmental Requirements

Temperature	50° F to 86° F
Humidity	15% to 85%
Noise during operation (BW/Color)	C364e: 71.6 dB/71.8 dB C284e: 68.8 dB/69.4 dB C224e: 66.7 dB/67.6 dB
Noise during feeder operation (FS-534/FS-533)	C364e: 69.2 dB or less C284e: 68.0 dB or less C224e: 67.6 dB or less
Noise during standby	40.5 dB or less
Ozone emission	Color: 3.0 mg/h Color: 1.5 mg/h

Electrical Requirements

Line Options	Dedicated	NEMA Diagram for 5-15R
Voltage:	110 V/120 to 127 V/220 to 240 V AC	
Amperage	12 A	
Cycles	60 Hz	
NEMA Part No:	5-15R	
Cord Length	6.6 ft.	

Note: The main electrical outlet must be located within 6.6 feet from the right rear corner of the bizhub C364e/C284e/C224e main unit.

Space Requirements

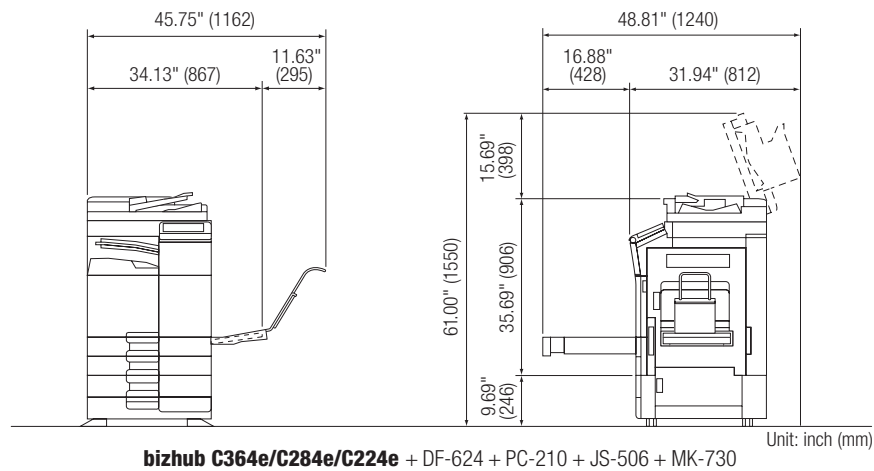
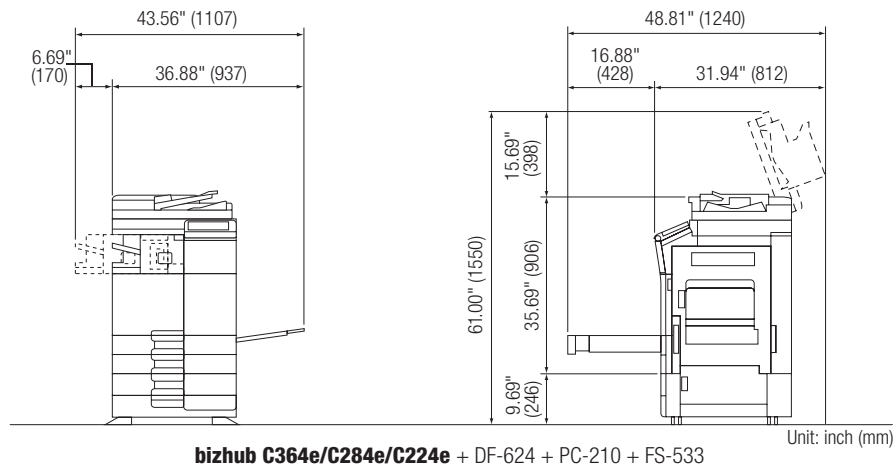
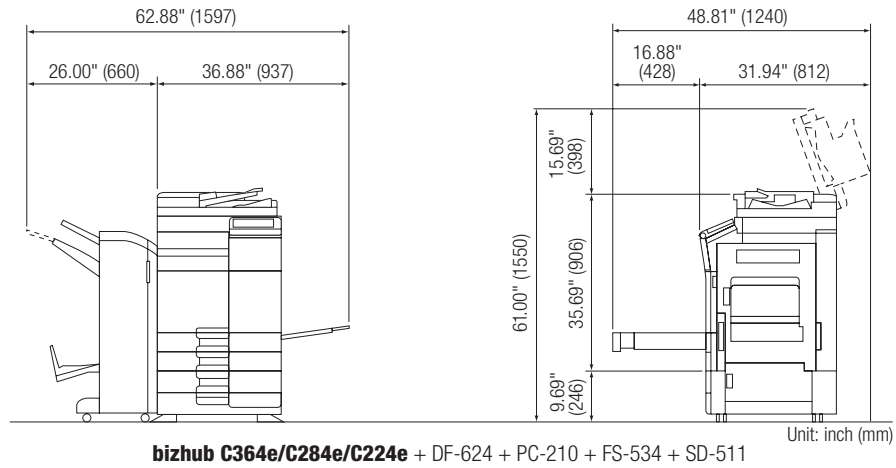

NOTICE: Be sure to allow a clearance of 8 inches (200 mm) or more at the back of this machine for the ventilation duct.

Component Considerations

Automatic Duplex Unit (Standard)



Support Paper Type	Thin Paper (14 lb. to 15.5 lb.) Plain Paper (16 lb. to 24 lb.) Thick Paper 1 (24.25 lb. to 32 lb.) Thick Paper 1+ (32.25 to 41.75 lb.) Thick Paper 2 (42 lb. to 55.5 lb.) Thick Paper 3 (55.75 lb. to 68 lb.) Recycled Paper (16 lb. to 24 lb.) Special Paper (16 lb. to 24 lb.) Letterhead (16 lb. to 24 lb.) Color Paper (16 lb. to 24 lb.)
Support Paper Size	12.25" x 18" to 5.5" x 8.5"; 4" x 6"; SRA3; 8" x 13"; Custom: (W) 3.9" to 12.625" x (L) 5.8" to 18"
Power Requirements	Supplied from main unit

*There are six Foolscap sizes: 220 x 330mm (☐), 8.5" x 13.5", 8.5" x 13" (☐), 8.25" x 13" (☐), 8.12" x 13.25" (☐) and 8" x 13" (☐). Any one of these sizes can be selected. For details, please consult with your authorized Konica Minolta Service representative.

OC-511 Original Cover



Type	Original Cover/Platen Cover
------	-----------------------------

DF-701 Dual Scanner Document Feeder



Type	Single Pass Duplex Document Feeder
Support Paper Size	1-Sided/2-Sided Originals/Mixed Originals: 11" x 17"☐ to 5.5" x 8.5"☐
Support Paper Weight	Single-Sided/Double-Sided: 9.25 lb. bond to 44 lb. bond Mixed Original: 13.5 lb. bond to 34 lb. bond 1-Sided Thin Paper (9.25 lb. to 13.063 lb.) 1-Sided Plain Paper (13.25 lb. to 44 lb.) 2-Sided Plain Paper (13.25 lb. to 44 lb.) Mixed Original Plain Paper (13.25 lb. to 34 lb.)
Paper Capacity	Max. 100 sheets (21.25 lb.)(Single-Sided/Double-Sided Originals)
Paper Transfer Speed	80 image/min (one-sided @ 300 dpi) (B&W/Color) 160 image/min (two-sided @ 300 dpi) (B&W/Color)
Power Requirements	Supplied from main unit.
Max. Power Consumption	74.5 W or less
Dimensions WxDxH	24.1" x 19.8" x 5.6"
Weight	Approximately 26.5 lb.

Konica Minolta bizhub C364e/C284e/C224e



Specification & Installation Guide



Component Considerations

DF-624 Reversing Automatic Document Feeder



Type	Reversing Automatic Document Feeder
Support Paper Size	1-Sided/2-Sided Originals/Mixed Originals: 11" x 17"  to 5.5" x 8.5" 
Support Paper Weight	Single-Sided/Double-Sided: 9.25 lb. bond to 34 lb. bond Mixed Original: 13.5 lb. bond to 34 lb. bond 1-Sided Thin Paper (9.25 lb. to 13.063 lb.) 1-Sided Plain Paper (13.25 lb. to 34 lb.) 2-Sided Plain Paper (13.25 lb. to 34 lb.) Mixed Original Plain Paper (13.25 lb. to 34 lb.)
Paper Capacity	Max. 100 sheets (21.25 lb.)(Single-Sided/Double-Sided Originals)
Paper Transfer Speed	80 image/min (one-sided @ 300 dpi) (B&W/Color) 37 image/min (two-sided @ 300 dpi) (B&W/Color)
Power Requirements	Supplied from main unit.
Max. Power Consumption	60.0 W or less
Dimensions WxDxH	24.1" x 19.8" x 5.6"
Weight	Approximately 19.75 lb.

Component Considerations continued

FK-511 Fax Kit

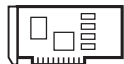

Memory Size	2048 MB (Standard)
Number of Stored Pages	10,000 Pages (approx. 700 characters per page when 8.5" x 11" document is stored using fine resolution)
Number of Fax Lines	1 Fax Line (Standard); Add second FK-511 Fax Kit for dual line fax capabilities.
Communication	ECM/Super G3
Compatible Lines	PSTN, PBX
Scanning Line Density	Ultra Fine: 600 x 600 dpi Super Fine: 16 dot/mm x 15.4 line/mm, 400 x 400 dpi Fine: 8 dot/mm x 7.7 line/mm, 200 x 200 dpi Normal: 8 dot/mm x 3.85 line/mm
Modem Speed	2.4 kbps-33.6 kbps
Compression	MH/MR/MMR/JBIG
Scanning/(Sending) Paper Size	Original Glass: Max. 11" x 17" ADF: 11" x 39" (Normal, Fine, Super Fine) 11" x 17" (Ultra Fine, Manual TX)
Recording Paper Size	11" x 17" to 5.5" x 8.5"
Transmission Speed	Less than 3 sec. (V.34, 33.6 Kbps, JBIG)
Scan Speed	2 sec. (Letter/Fine Mode)
Number of Abbr. Dial	2000
Number of Program Dial	400
Number of Group Dial	100 (Up to 500 destinations per group)
Sequential Multiple Station Transmission	Max. 600
Transmitting Functions	2-in-1 TX, Mixed Original, F-Code Transmission, Frame Erase Transmission, Sharpness, Header/Footer, Memory Transmission, Quick Memory Transmission, Timer Transmission, Incomplete Transmission Hold, Manual Transmission, Confidential Transmission, Password Transmission, Polling Transmission, Bulletin Function, Relay Transmission, Fax Forwarding Function, Overseas TX, V.34 OFF, ECM OFF
Receiving Functions	Duplex Print (RX), Manual Reception, Confidential Reception, Memory Reception, Polling Reception, Bulletin Function, Fax Forwarding (to any destination stored in the Address Book), TSI Routing (to any destination stored in the Address Book).

Component Considerations

FS-534 Staple Finisher (50 sheets)

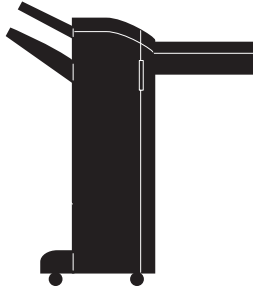

Type	Staple Finisher
Output Trays	Output Tray 1, Output Tray 2, Folding Output Tray (Top of RU unit)
Support Paper Type	<p>Output Tray 1 & Output Tray 2: Thin Paper (14 lb. to 15 lb.), Plain Paper (16 lb. bond to 24 lb. bond), Recycled Paper (16 lb. to 24 lb.), Thick Paper 1/1+ (24.25 lb. bond to 79.75 lb. bond), OHP Transparencies, Postcards*, Envelopes*, Label Sheets*, Letterhead*, Tabs*, Banner Paper*. Staple Settings: Thin Paper (14 lb. to 15 lb.), Plain Paper (16 lb. bond to 23.94 lb. bond), Recycled Paper (16 lb. to 24 lb.), Thick Paper 1 (24.25 lb. bond to 32 lb. bond), Thick Paper 1+ (32.25 lb. to 41.75 lb.), Thick Paper 2 (42 lb. to 55.5 lb.) * Fed into Output Tray 1</p>
Support Paper Size	<p>Output Tray 1: 12.25" x 18", 11" x 17" to 5.5" x 8.5" □/□ Output Tray 2: Group/Sort: 12.25" x 18", 11" x 17", 5.5" to 8.5" □/□ Offset Group/Offset Sort: 12.25" x 18", 11" x 17" to 5.5" to 8.5", SRA3 Width: 7.188" to 12.625"; Length 5.875" to 18" Staple: 11" x 17" to 7.25" x 10.5" □/□ Width: 7.188" to 11.688"; Length 5.875" to 17" Folding Output Tray: 12.25" x 18", 11" x 17" to 5.5" x 8.5" □/□ Width: 3.5" to 12.5"; Length 5.5" to 18"</p>
Mode	Non-Sort, Sort, Group, Sort/Offset, Group/Offset, Sort and Staple
Stacking Capacity	<p>Output Tray 1: Thin Paper (14 lb. to 15.5 lb.), Plain Paper (16 lb. to 24 lb.): 200 sheets. Thick Paper (24.25 to 79.75 lb.), OHP Transparencies, Postcards, Envelopes or Label Sheets, Letterheads, Tabs: 20 sheets Output Tray 2 – Group/Sort Mode: Plain Paper (16 lb. to 24 lb.): 3,000 sheets of 8.5" x 11" or smaller, or 1,500 sheets of 8.5" x 14" or larger; or 500 sheets of 5.5" x 8.5" or smaller. Thick Paper (24.25 to 79.75 lb.), OHP Transparencies, Postcards, Envelopes, Labels, Letterheads, Tabs: 20 sheets 2nd Tray – Offset Group/Offset Sort: 3,000 sheets (8.5" x 11" or smaller); 1,500 sheets (8.5" x 14" or larger); 500 sheets (5.5" x 8.5" or larger) Thin Paper (14 lb. to 15 lb.) Plain Paper (16 lb. to 24 lb.) Recycled Paper (16 lb. to 24 lb.) Thick Paper (24.25 lb. to 79.75 lb.), OHP Transparencies, Postcard, Envelope, Label sheets, Letterhead, Tabs: 20 sheets Staple Thin Paper (14 lb. to 15 lb.): 50 sheets Plain Paper (16 lb. to 24 lb.): 50 sheets Recycled Paper (16 lb. to 24 lb.): 50 sheets Thick Paper (24.25 lb. to 32 lb.): 30 sheets Thick Paper 1+ (32.25 lb. to 41.75 lb.): 30 sheets Thick Paper 2 (42 lb. to 55.5 lb.): 20 sheets 2–9 Sheets: 100 Sets 10–20 Sheets: 50 Sets 21–30 Sheets: 30 Sets 31–40 Sheets: 25 Sets 41–50 Sheets: 20 Sets Folding Output Tray: 100 sheets Thin Paper (14 lb. to 15.5 lb.) Plain Paper (16 lb. to 24 lb.) Recycled Paper (16 lb. to 24 lb.) Thick Paper (24.25 lb. to 79.75 lb.): 20 sheets</p>
Staple Mode	Paper Sizes: 8.5" x 11" to 11" x 17"; Corner, 2 Position (Side, Top)

continued

Component Considerations continued

FS-534 Staple Finisher continued

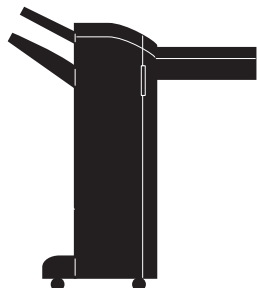















Available Options	PK-520 Punch Kit (2/3-hole Punch), Saddle Stitcher SD-511
Power Requirements	Supplied from Main Unit
Max. Power Consumption	Less than 56 W
Dimensions (W x D x H)	20.81" x 25.25" x 40.25" (When tray is pulled out 25.88" (W))
Weight Approx.	88.188 lb.
Consumables	SK-602 Staples (5,000 Staples x 3)

NOTE: FS-534 supports banner printing when installed on C754/C654/C364e/C364/C284e/C284/C224e/C224/754/654.

FS-533 Inner Finisher (Staple Function only) (50 sheets)



Type	Inner Staple Finisher
Output Trays	Output Tray 1
Support Paper Types	<p>Group/Sort: Thin Paper (14 lb. to 15 lb.), Plain Paper (16 lb. bond to 24 lb. bond), Recycled Paper (16 lb. to 24 lb.), Thick Paper (24.25 lb. bond to 79.75 lb. bond), OHP Transparencies, Postcards, Envelopes, Label Sheets, Letterhead, Tabs, Banner Paper.</p> <p>Offset Group, Offset Sort: Thin Paper (14 lb. to 15 lb.), Plain Paper (16 lb. bond to 24 lb. bond), Recycled Paper (16 lb. to 24 lb.), Thick Paper (24.25 lb. bond to 79.75 lb. bond)</p> <p>Staple Settings: Thin Paper (14 lb. to 15 lb.), Plain Paper (16 lb. bond to 23.94 lb. bond), Recycled Paper (16 lb. to 24 lb.), Thick Paper (24.25 lb. bond to 55.25 lb. bond)</p>
Mode	Group, Sort, Offset Group, Offset Sort, Staple
Support Paper Size	<p>Group/Sort: 12.25" x 18" , 11" x 17"  to 5.5" x 8.5" / , 4" x 6" , SRA3 </p> <p>Width: 3.56" to 12.625"; Length: 5.5" to 47.25"</p> <p>Offset Group/Offset Sort: 12.25" x 18" , 11" x 17" , 8.5" x 11" , 7.25" x 10.5" </p> <p>Width: 8.25" to 11.69"; Length: 7.17" x 17"</p> <p>Staple: 11" x 17" , 8.5" x 14" , 8.5" x 11" , 7.25" x 10.5" </p> <p>Width: 8.25" to 11.69"; Length: 7.17" x 17"</p>
Stacking Capacity	<p>Group, Sort, Offset Group, Offset Sort: Thin Paper (14 lb. to 15 lb.), Plain Paper (16 lb. bond to 24 lb. bond), Recycled Paper (16 lb. to 24 lb.): 500 sheets of 8.5" x 11" or smaller; or 250 sheets of 8.5" x 14" or larger Thick Paper (24.25 lb. bond to 79.75 lb. bond), OHP Transparencies, Postcards, Envelopes, Label Sheets, Letterhead, Tabs, Banner Paper: 10 sheets</p> <p>Staple: Thin Paper (14 lb. to 15 lb.), Plain Paper (16 lb. bond to 24 lb. bond), Recycled Paper (16 lb. to 24 lb.): 50 sheets of 8.5" x 11" or smaller; or 30 sheets of 8.5" x 14" or larger Thick Paper (24.25 lb. bond to 55.5 lb. bond): 2 sheets</p>
Staple Mode	Corner Front / Back 2-point
Available Options	PK-519 Punch Kit (2-3-hole Punch)
Power Requirements	Supplied from Main Unit
Max. Power Consumption	Less than 40W
Dimensions (W x D x H)	18.6" x 23" x 7.7"
Weight Approx.	26.5 lb.
Consumables	SK-602 Staples (5,000 Staples x 3)

Component Considerations

PK-519 Punch Kit (For FS-533)



Applicable	Finisher FS-533
Number of holes	2 or 3 holes
Support Paper Weight	Thin Paper (14 lb. to 15.5 lb.), Plain Paper (16 lb. to 24 lb.), Thick paper (24.25 lb. bond to 79.75 lb. bond)
Support Paper Size	2-hole Punch Setting: 11" x 17", 8.5" x 14", 8.5" x 11" 3-hole Punch Setting: 11" x 17", 8.5" x 11"
Power Requirements	Supplied from Finisher FS-533
Dimensions (WxDXH)	4.33" x 19.03" x 8"
Weight Approx.	Approx. 7 lb.

PK-520 Punch Kit (For FS-534)



Applicable	FS-534
Number of holes	2 or 3 holes
Support Paper Weight	Thin Paper (14 lb. to 15.5 lb.), Plain Paper (16 lb. bond to 24 lb. bond), Recycled Paper (16 lb. to 24 lb.),
Support Paper Size	2-hole Punch Setting: 11" x 17", 8.5" x 14", 8.5" x 11" 3-hole Punch Setting: 11" x 17", 8.5" x 11"
Power Requirements	Supplied from Finisher FS-534
Dimensions (W x D x H)	2.375"x 19.375" x 5.563"
Weight Approx.	Approx. 3.938 lb.

SD-511 Saddle Stitcher (For FS-534)

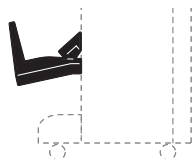

Applicable	FS-534
Number of bins	1 Tray
Paper types	Thin Paper (14 lb. to 15.5 lb.), Plain Paper (16 to 24 lb), Thick Paper 1/1+2 (24.25 to 55.5 lb.)* <small>*Can only be used as a cover page.</small>
Paper sizes	12.25" x 18" □, 11" x 17", 8.5" x 14" □, 8.5" x 11",
Number of Center Stapled or Half-Folded Sheets	Plain Paper (16 to 24 lb.) 1-3 Sheets: 20 Sets 4-10 Sheets: 10 Sets 11-20 Sheets: 5 Sets
Number of Tri-Folded Sheets	1 Sheet: 30 Sets 2-3 Sheets: 10 Sets
Staple mode	Booklet, 2-point staple
Maximum staple sheet	20 sheets: (19 sheets/14 to 24 lb.) + (1 sheet/13 to 55.5 lb.)
Dimensions (W x D x H)	8.25" x 21.88" x 21.56"
Weight	52.94 lb.
Consumables	SK-602 (5,000 x 3 pkg/case)
Power requirements	Supplied from finisher

Component Considerations continued

JS-506 Job Separator Tray



Output tray	Output Tray 1, Output Tray 2
Mode	Group, Sort, Offset Group*, Offset Sort* * Fed into Output Tray2
Support Paper Types	Group/Sort: Thin Paper (14 lb. to 15.5 lb.), Plain Paper (16 lb. bond to 24 lb. bond), Recycled Paper (16 lb. to 24 lb.), Thick Paper (24.25 lb. bond to 79.75 lb. bond), OHP Transparencies, Postcards*, Envelopes, Label Sheets, Letterhead, Tabs*, Banner Paper*. Offset Group, Offset Sort: Thin Paper (14 lb. to 15.5 lb.), Plain Paper (16 lb. bond to 24 lb. bond), Recycled Paper (16 lb. to 24 lb.), Thick Paper (24.25 lb. bond to 79.75 lb. bond) * Fed into Output Tray 2
Support Paper Size	Output Tray 1: 12.25" x 18"□, 11" x 17"L to 5.5" x 8.5"□/□, SRA3□ Width: 3.56" to 12.625"; Length: 5.5" to 18" Output Tray 2: Group/Sort: 12.25" x 18"□, 11" x 17"□ to 5.5" x 8.5"□/□, 4" x 6"□, SRA3□ Width: 3.56" to 12.625"; Length: 5.5" to 47.25" Offset Group/Offset Sort: 11" x 17"□, to 7.25" x 10.5"□/□ Width: 7.17" to 12.25"; Length: 5.8" to 18"
Stacking Capacity	Output Tray 1: Thin Paper (14 lb. to 15.5 lb.), Plain Paper (16 lb. bond to 24 lb. bond), Recycled Paper (16 lb. to 24 lb.): 100 sheets Output Tray 2: Group/Sort: Thin Paper (14 lb. to 15.5 lb.), Plain Paper (16 lb. bond to 24 lb. bond), Recycled Paper (16 lb. to 24 lb.): 150 sheets; Thick Paper (24.25 lb. bond to 79.75 lb. bond), Transparency, Postcard, Label sheets: 20 Sheets; Envelope: 10 Sheets; Banner Paper: 1 Sheet Offset Group/Offset Sort: Thin Paper (14 lb. to 15.5 lb.), Plain Paper (16 lb. bond to 24 lb. bond), Recycled Paper (16 lb. to 24 lb.): 150 sheets; Thick Paper (24.25 lb. bond to 79.75 lb. bond): Not specified
Power Requirements	Supplied from Main Unit
Max. Power Consumption	Less than 24W
Dimensions (W x D x H)	19.4" x 18.5" x 8.9"
Weight Approx.	3.3 lb.

Component Considerations

PC-110 Paper Feed Cabinet



Type	1 x 500 sheet universal drawer + storage
Support Paper Types	Thin Paper (14 lb. to 15.5 lb.), Plain Paper (16 lb. bond to 24 lb. bond), Recycled Paper (16 lb. to 24 lb.), Single Side Only Paper (16 lb. bond to 24 lb. bond), Special Paper (16 lb. bond to 24 lb. bond), Letterhead (16 lb. bond to 24 lb. bond), Colored Paper (16 lb. bond to 24 lb. bond), Thick Paper 1 (24.25 lb. bond to 32 lb. bond), Thick Paper 1+ (32.25 lb. bond to 41.75 lb. bond), Thick Paper 2 (42 lb. bond to 55.5 lb. bond), Thick Paper 3 (55.75 lb. bond to 68 lb. bond)
Support Paper Size	11" x 17" (L) to 8.5" x 11" (L/P), 5.5" x 8.5" (L), 8" x 13" (L)* * There are six Foolscap sizes: 220 x 330mm, 8.5" x 13.5", 8.5" x 13", 8.25" x 13, 8.12" x 13.25" and 8" x 13". Only one of these sizes can be selected. For details, please consult with your authorized Konica Minolta Service representative.
Paper Capacity	Tray 3: Thin paper, Plain paper, Recycled paper, 1-sided special paper, Special paper, Letterhead, Colored paper: 500 sheets, Thick 1, Thick 1+, Thick 2, Thick 3: 150 sheets
Power Requirements	Supplied from Main Unit
Max. Power Consumption	Less than 15W
Dimensions (W x D x H)	24.2" x 25.7" x 11.6"
Weight Approx.	48.5 lb.

PC-210 Paper Feed Cabinet



Type	2 x 500 sheet universal drawers
Support Paper Types	Thin Paper (14 lb. to 15.5 lb.), Plain Paper (16 lb. bond to 24 lb. bond), Recycled Paper (16 lb. to 24 lb.), Single Side Only Paper (16 lb. bond to 24 lb. bond), Special Paper (16 lb. bond to 24 lb. bond), Letterhead (16 lb. bond to 24 lb. bond), Colored Paper (16 lb. bond to 24 lb. bond), Thick Paper 1 (24.25 lb. bond to 32 lb. bond), Thick Paper 1+ (32.25 lb. bond to 41.75 lb. bond), Thick Paper 2 (42 lb. bond to 55.5 lb. bond), Thick Paper 3 (55.75 lb. bond to 68 lb. bond)
Support Paper Size	11" x 17" (L) to 8.5" x 11" (L/P), 5.5" x 8.5" (L), 8" x 13" (L)* *There are six Foolscap sizes: 220 x 330mm (☐), 8.5" x 13.5", 8.5" x 13" (☐), 8.25" x 13 (☐), 8.12" x 13.25" (☐) and 8" x 13" (☐). Any one of these sizes can be selected. For details, please consult with your authorized Konica Minolta Service representative.
Paper Capacity	Tray 3: Thin paper, Plain paper, Recycled paper, 1-sided special paper, Special paper, Letterhead, Colored paper: 500 sheets, Thick 1, Thick 1+, Thick 2, Thick 3: 150 sheets Tray 4: Thin paper, Plain paper, Recycled paper, 1-sided special paper, Special paper, Letterhead, Colored paper: 500 sheets, Thick 1, Thick 1+, Thick 2, Thick 3: 150 sheets
Power Requirements	Supplied from Main Unit
Max. Power Consumption	Less than 15W
Dimensions (W x D x H)	24.2" x 25.7" x 11.6"
Weight Approx.	53 lb.

Component Considerations continued

PC-410 Paper Feed Cabinet



Type	Large Capacity Cassette
Support Paper Types	Thin Paper (14 lb. to 15.5 lb.), Plain Paper (16 lb. bond to 24 lb. bond), Recycled Paper (16 lb. to 24 lb.), Single Side Only Paper (16 lb. bond to 24 lb. bond), Special Paper (16 lb. bond to 24 lb. bond), Letterhead (16 lb. bond to 24 lb. bond), Colored Paper (16 lb. bond to 24 lb. bond), Thick Paper 1 (24.25 lb. bond to 32 lb. bond), Thick Paper 1+ (32.25 lb. bond to 41.75 lb. bond), Thick Paper 2 (42 lb. bond to 55.5 lb. bond), Thick Paper 3 (55.75 lb. bond to 68 lb. bond)
Support Paper Size	8.5" x 11" 
Paper Capacity	Thin paper, Plain paper, Recycled paper, 1-sided special paper, Special paper, Letterhead, Colored paper: 2500 sheets, Thick 1, Thick 1+, Thick 2, Thick 3: 1000 sheets
Power Requirements	Supplied from Main Unit
Max. Power Consumption	Less than 45W
Dimensions (W x D x H)	24.2" x 25.7" x 11.6"
Weight Approx.	50.7 lb.

DK-510 Copy Desk



Type	Storage drawer only
Function	Stores printing materials such as paper or toner. Required when additional paper drawers are not installed, to bring the device to operational height
Dimensions (WxDxH)	24.2" x 25.7" x 11.6"
Weight Approx.	46.3 lb.

KP-101 10-Key Pad



Type	10-Key Pad
Function	Provides hard keys for entering numerical values and supports Voice Guidance function available with optional LK-104 v3 i-Option License Kit. Meets Section 508 Accessibility requirements.

Component Considerations

AU-102 Biometric Authentication Unit



Biometric Sensor System	Transmission-type optical system
Verification Time	Approx. 1 sec. or less
Interface	USB 2.0
Dimensions WxDxH	Approx. 2.32" x 3.25" x 2.94"
Weight	Approx. 3 oz. (excluding USB cable)
Max. Power Consumption	DC 5 V, 500 mA
System Conditions (during operation)	Ambient temperature: 41° to 95° (F) Humidity: 20% to 80% (No dew condensation)
System Conditions (during non-operation)	Ambient temperature: 32° to 122° (F) Humidity: 20% to 80% (No dew condensation)
MFP Compatibility	bizhub C754, C654, C652DS, C652, C554, C552DS, C552, C454, C452, C364e, C364, C360, C284e, C284, C280, C224e, C224, C220, 754, 654, 552, 423, 363, 283, 223. Please check MyKonicaMinolta.com on a regular basis for compatibility updates.

NOTE: WT-506 Working Table is required for AU-102 Biometric Authentication Unit.

AU-201H HID Proximity Card Authentication Unit



Dimensions (WxHxD)	3.625" x 2.5" x 0.625"
Weight	0.25 lb.
Power Supply	Supplied from USB Port
System Conditions (operating mode)	Ambient Temperature: 32° to 104° F Humidity: 20% to 85%
System Conditions (non-operating mode)	Ambient Temperature: -4° to 122° F Humidity: 20% to 85%
Radio Law Division	Self-Guided Read-Write Communication Facility
Applicable Card	ISO 14443 Type A, FeliCa-based non-contact IC Card
Acquired Standard	VCCI Class B
Compatible Computer	CPU: PC/T Compatible, 1 GHz or more Memory: 128 MB or more HDD: 100 MB or more free space Monitor: 800 x 600 pixels, 16-bit color or more Network: TCP/IP Application: Microsoft Internet Explorer 6.0 (SP1) or later Microsoft .NET Framework (SP1) or later
MFP Compatibility	bizhub C754, C654, C650, C554, C552, C550, C454, C452, C451, C364e, C364, C360, C353, C284e, C284, C280, C253, C224e, C224, C220, C203, 754, 654, 552, 501, 423, 363, 283, 223. Please check MyKonicaMinolta.com on a regular basis for compatibility updates.

NOTE: WT-506 Working Table or MK-735 Mount Kit (internal mount) is required for AU-201H HID Proximity Card Authentication Unit.

Component Considerations continued

AU-202H HID iClass Card Reader



Dimensions (WxHxD)	4.0" x 1.9" x 0.09"
Weight	0.25 lb.
Power Supply	Supplied from USB Port
System Conditions (operating mode)	Ambient Temperature: 31° to 150° F Humidity: 5% to 95%
Transmit Frequency	13.56 MHz
Environmental	IP55
Certifications	UL294/cUL (US), FCC Certification (US), IC (Canada), RoHS
Card Type Compatibility	All HID 2k, 16k or 32k iClass Cards
HID iClass Card Format Compatibility	26-bit, HID Corporate 1000®
MFP Compatibility	bizhub C754, C654, C652DS, C652, C554, C552DS, C552, C454, C452, C364e, C364, C360, C284e, C284, C280, C224e, C224, C220, 754, 654, 552, 423, 363, 283, 223. Please check MyKonicaMinolta.com on a regular basis for compatibility updates.

NOTE: WT-506 Working Table or MK-735 Mount Kit (internal mount) required for AU-202H HID iClass Card Reader.

AU-204H Magnetic Stripe Card Reader



Dimensions (WxHxD)	1.28" x 1.23" x 3.94"
Weight	4.5 oz.
Power Supply	Supplied from USB Port
System Conditions (operating mode)	Ambient Temperature: 40° to 158° F Humidity: 10% to 90%
Transmit Frequency	3-60 i.p.s.
Certifications	ISO 7810 and ISO 7811/AAMVA
Card Type Compatibility	All magnetic stripe cards
MFP Compatibility	bizhub C754, C654, C650, C554, C552DS, C552, C550, C454, C452, C451, C364e, C364, C360, C353, C284e, C284, C280, C253, C224e, C224, C220, C203, 754, 654, 501, 423, 363, 283, 223. Please check MyKonicaMinolta.com on a regular basis for compatibility updates.

NOTE: WT-506 Working Table required for AU-204H Magnetic Stripe Card Reader.

Component Considerations

AU-211P CAC/PIV Solution w/Certificate



Dimensions (WxHxD)	2.75" x 2.75" x 0.39"
Weight	0.13 lbs.
Power Supply	Supplied from USB Port
System Conditions (operating mode)	0° to 122° F
Interface	Full Speed USB (12 Mbps)
Connector Shape	USB A Type Connector
Compatible Card	PKI-C-Card (PIV, CAC)
MFP Compatibility	bizhub C754, C654, C554, C552, C454, C452, C364e*, C364, C360, C284e*, C284, C280, C224e*, C224, C220, 754, 654, 552, 501, 423, 363, 283, 223. Please check MyKonicaMinolta.com on a regular basis for compatibility updates. *Anticipated availability Summer 2013.

NOTE: WT-506 Working Table required. Please contact your local Government Account Manager for additional information.

WT-506 Working Table

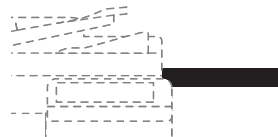

Type	External Table
Function	Holds AU-102 Biometric Authentication Unit, AU-201H HID Proximity Card Reader ¹ , AU-202H HID iClass Reader ² , AU-204H Magnetic Stripe Card Reader ³ or AU-211P CAC/PIV Solution ⁴ ; Can be used as a place holder for originals and/or output.
Dimensions WxDxH	18.30" x 16.33" x 1.5"

¹ AU-201H HID Proximity Reader can be mounted on WT-506 (or internally with MK-735).

² AU-202H HID iClass Reader must be mounted on WT-506 (or internally with MK-735).

³ AU-204H Magnetic Stripe Card Reader requires WT-506.

⁴ AU-211P requires WT-506. Please contact your local Government Account Manager for additional information.

Anticipated availability Summer 2013 (C364e, C284e, C224e, 754, 654).

EK-606 USB Host/Local Interface



Type	USB Interface and USB Cable
Function	Required to connect optional External Keyboard (or can use EK-607 when Bluetooth printing is also required) or optional i-Option LK-104 v3 Voice Guidance License kit.

EK-607 USB Host/Local Interface with Bluetooth



Type	USB Interface and USB Cable
Function	Supports Bluetooth Printing. Required to connect optional External Keyboard (or can use EK-606 if Bluetooth printing is not required) or optional i-Option LK-104 v3 Voice Guidance License kit.

Component Considerations continued

MK-735 Mount Kit



Type	Internal Component
Function	Required if you wish to install the AU-201H or AU-202H internally in the device.

IC-414 Fiery Image Controller*



Type	Embedded Type
CPU	Intel® Pentium E5300 2.6 GHz
Memory	2 GB
HDD	160 GB
Continuous Print Speed	Same as Continuous Copy (when using the same original)
Resolution	600 dpi, 1200 dpi
Page Description Language	Adobe PostScript 3 version 3019, PCL6, PDF v1.7
Support Protocol	Ethernet (Apple Talk, TCP/IP), HTTP/HTTPS, XPS, SSL/TLS for HTTPS, SNMP, SMP, Port 9100 (Bi-Directional), IPP, LDAP, IPv6 Phase II, SNMP v3
Support OS	Windows XP, Windows XP x64, Windows 2003 Server, Windows 2003 Server x64, Windows Vista, Windows Vista x64, Windows 7, Windows 7 x64, Windows 2008 Server (utility only), Windows 2008 Server x64 (utility only); Mac OS X 10.4.11, 10.5x, 10.6x or later; UNIX/Linux.
Standard Fonts	Adobe PS 138 Roman fonts; Agfa PCL 80 Roman fonts; 1 bitmap font; Additional PCL 35 fonts; Euro Currency Resident font
Interface	10Base-T/100Base-TX/1000Base-T, USB

*Not available on bizhub C224e.

VI-506 Interface Kit



Type	Interface Kit
Function	Required interface kit to connect IC-414 Fiery Image Controller to MFP.

LK-101 v3 i-Option License Kit

Type	License Key
Function	Web Browser functions.

LK-102 v3 i-Option License Kit

Type	License Key
Function	Enhanced PDF Encryption (128-bit AES Encryption), PDF/A (1a/1b) and Linearized PDF file support.

LK-104 v3 i-Option License Kit

Type	License Key
Function	Voice Guidance

Component Considerations

LK-105 v3 i-Option License Kit

Type	License key
Function	Provides Searchable PDF function

LK-106 i-Option License Kit

Type	License key
Function	Supports Bar Code Font Printing

LK-107 i-Option License Kit

Type	License key
Function	Supports Unicode Font Printing

LK-108 i-Option License Kit

Type	License key
Function	Supports OCR Font Printing

LK-110 i-Option License Kit

Type	License Key
Function	OOXML format file conversion for docx/xlsx, Fax to searchable PDF, convert box data to compact PDF, direct print e-mail attached file. Combines LK-102 (Encrypted PDF) & LK-105 (Searchable PDF/OCR) functionality.

LK-111 i-Option License Kit

Type	License Key
Function	Provides ThinPrint client support.

UK-204 i-Option Upgrade Kit

Type	2 GB Memory Upgrade (for i-Option License Kits)
Function	Required for LK-101 v3 Web Browser, LK-102 v3 Enhanced PDF Encryption, PDF/A, Linearized PDF, LK-104 v3 Voice Guidance, LK-105 Searchable PDF, LK-106 Bar Code Font, LK-107 Unicode Font, LK-108 OCR Font and PageScope My Panel, LK-110 Enhanced Image Data (only one upgrade kit required per device).

SC-508 Copy Guard Kit

Type	Embedded Type
Function	Prevents printing of Copy Protected documents.

Please note that two SC-508 Copy Guard Kits are required when the C364e/C284e/C224e are equipped with the optional DF-701 Dual Scan Document Feeder (one Copy Guard Kit required for each side scanned).

Konica Minolta bizhub C364e/C284e/C224e

Specification & Installation Guide



Mixed Original Support

● Possible ✕ Not Possible

Document Size ²	Maximum Document Width ¹					
	11" x 17" landscape	8.5" x 11" portrait	8.5" x 14" landscape	8.5" x 11" landscape	5.5" x 8.5" portrait	5.5" x 8.5" landscape
11" x 17" (☐)	●	●	✕	✕	✕	✕
8.5" x 11" (☐)	●	●	✕	✕	✕	✕
8.5" x 14" (☐)	●	●	●	●	●	✕
8.5" x 11" (☐)	●	●	●	●	●	✕
5.5" x 8.5" (☐)	✕	✕	●	●	●	✕
5.5" x 8.5" (☐)	✕	✕	✕	✕	✕	●

¹ Indicates the width of the widest document size of the mixed originals.

² Indicates the document sizes that can be mixed together based on the maximum document width.

Standard Paper Tray Support

Main Unit – bizhub C364e/C284e/C224e (Paper Tray 1 and 2)			
Component	Capacity	Size	Weight
Tray 1	500 sheets	11" x 17"	14 lb. bond to 68 lb. bond
Tray 2	500 sheets	12" x 18"	14 lb. bond to 68 lb. bond
Bypass	150 sheets	12" x 18"	16 lb. bond to 79.75 lb. bond

Konica Minolta bizhub C364e/C284e/C224e

Specification & Installation Guide



KONICA MINOLTA

Print Controller (Standard)

Type	Internal Type												
CPU	800 MHz (shared with copier)												
Memory	2 GB (shared with copier) 250 GB HDD (shared with copier)												
Print Speed	<table border="1"> <thead> <tr> <th>Color/ BW:</th> <th>C364e</th> <th>C284e</th> <th>C224e</th> </tr> </thead> <tbody> <tr> <td></td> <td>36 ppm</td> <td>28 ppm</td> <td>22 ppm</td> </tr> <tr> <td></td> <td>Letter <input type="checkbox"/></td> <td>Letter <input type="checkbox"/></td> <td>Letter <input type="checkbox"/></td> </tr> </tbody> </table>	Color/ BW:	C364e	C284e	C224e		36 ppm	28 ppm	22 ppm		Letter <input type="checkbox"/>	Letter <input type="checkbox"/>	Letter <input type="checkbox"/>
Color/ BW:	C364e	C284e	C224e										
	36 ppm	28 ppm	22 ppm										
	Letter <input type="checkbox"/>	Letter <input type="checkbox"/>	Letter <input type="checkbox"/>										
Print Resolution	600 x 600 dpi (1800 equivalent x 600 dpi), 1200 x 1200 dpi												
PDL	PCL 5e/c emulation, PCL6 (XL version 3.0), PS 3 (Version 3016) Emulation, XPS												
Protocol	TCP/IP (IPv4/IPv6), BOOTP, ARP, ICMP, DHCP, DHCPv6, AutoIP, SLP, SNMP, FTP, LPR/LPD, RAW Socket, SMB over TCP/IP, IPP, HTTP, POP, SMTP, LDAP, NTP, SSL, IPX, AppleTalk, Bonjour, NetBEUI, WebDAV, DPWS, S/MIME, IPsec, DNS, Dynamic DNS, LLNMR, LLTD, SSDP, SOAP												
Support OS	Windows 2000, Windows XP, Windows XP 64-bit, Windows Vista, Windows Vista 64-bit, Windows 7, Windows 7 64-bit, Windows 8, Windows 8 64-bit, Windows Server 2003 R2, Windows Server 2003 64-Bit, Windows Server 2008, Windows Server 2008 64-bit, Windows Server 2012 Standard, Windows Server 2012 Datacenter. Mac OS 9.2 or later; Mac OS X 10.2 or later; Mac OS X 10.4 (Intel) or later; Linux												
Font	PCL Resident Fonts: 80 Roman fonts PS3 Emulation Resident Fonts: 137 Roman Type 1 font												
Interface	Standard Ethernet (10Base-T/100Base-TX/ 1000Base T); Hi-Speed USB 2.0, USB 1.1, USB Host												

Fieri® IC-414 Embedded Image Controller*

Processor	Intel Pentium E5300 260 GHz
Operating System	Windows XP/XP 64 bit/2003 Server/2003 Server 64 bit/Vista/Vista 64 bit/Windows 7 (x32, x64) Windows 8 (x32, x64)(PS3 only)/2008 Server (utility only)/2008 Server 64 bit (utility only)/ 2012 Server 64 bit (utility only); Mac x 10.4.11; UNIX/Linux
RAM	2GB
Hard Disk Drive	160 GB
Page Description Language	Adobe PostScript 3 Version 3019, PCL6, PDF v1.7
Fonts	Adobe PS 138 Roman fonts, Agfa PDL 80 Roman fonts and 1 Bitmap font, Additional PCL 35 fonts, Euro Currency Resident font
Printer Driver	For PCL and PS: Windows 2000, Windows XP 32/64 bit, Windows Server 2003 32/64 bit, Windows Vista 32/64 bit, Windows 7 (x32, x64), Windows 8 (x32, x64), Windows Server 2008 32/64 bit (utilities only), Windows Server 2012 64 bit (utility only); Mac OS X 10.3.9, 10.4 or later, 10.6; UNIX/Linux
Interface	10Base-T/100Base-TX/1000Base-T, USB
Protocols	Ethernet (Apple Talk, TCP/IP), HTTP/HTTPS, SSL/TLS for HTTPS, SNMP, SMB, Port9100 (Bi-Directional), IPP, LDAP, IPV6 Phase II, SNMP v3
Utilities	ColorWise® Pro Tools 3.7 Command Workstation™ 4.5 (for Windows) Command Workstation™ 1.3 (for Mac) Fieri® Remote Scan 5.4 (TWAIN plug-in) Fieri® Web Tools 3.0
Software	<p>Standard:</p> <ul style="list-style-type: none"> Fieri® Command Workstation ColorWise Tools Fieri® Secure Erase Fieri® Spot-On Fieri® WebTools Remote Fieri® Scan Fieri® VUE <p>Optional:</p> <ul style="list-style-type: none"> Fieri® Productivity Package Fieri® Hot Folders/Virtual Printers Fieri® Auto Trapping Fieri® SeeQuence Impose Fieri® SeeQuence Compose Fieri® SeeQuence Impose & Compose Suite Fieri® Color Profiler Suite v4.0 ES-2000 ES-2000 Spectrophotometer

*Not available on bizhub C224e.

Network Functions

Sending the Scanned Data in an Email Message

The scanned data can be sent to a specified Email address. The destination is specified from the touch panel of this machine and the scanned data is sent as an Email attachment.

Sending the Scanned Data as Files (FTP)

The scanned data is uploaded to a specified FTP server. The FTP server address, login password, and other information are entered from the touch panel of this machine. The data files uploaded to the FTP server can be downloaded from a computer on the network.

Sending the Scanned Data to a Computer on the Network (SMB)

The scanned data can be sent to a shared folder on a specified computer. The name of the destination computer, login password, and other information are entered from the touch panel of this machine.

Saving the Scanned Data in Boxes

The scanned data is uploaded to a specified web server. The host name, file path, user name, and password are entered on the touch panel of the machine. The data files uploaded to the server can be downloaded from a computer on the network.

Using the Machine as a Scanner

This machine can best be used as a scanner. The scanner can be controlled from a PC connected to the network, and the scanned image can be loaded into an application on the PC to be processed.

Web Service (Optional)

This machine can be used to access the Internet. Optional LK-101 v3 and UK-204 required.

Print Drivers

Page Desc. Language	Print Driver	Supported Operating Systems
PCL Driver	Konica Minolta PCL Driver	Windows XP Home Edition (Service Pack 1 or later) Windows XP Professional (Service Pack 1 or later) Windows Server 2003, Standard Edition (Service Pack 1 or later) Windows Server 2003, Enterprise Edition (Service Pack 1 or later) Windows Server 2003 R2, Standard Edition Windows Server 2003 R2, Enterprise Edition Windows XP Professional x64 Edition Windows Server 2003 Standard x64 Edition Windows Server 2003, Enterprise x64 Edition Windows Server 2003 R2, Standard x64 Edition Windows Server 2003 R2, Enterprise x64 Edition Windows Vista Business* Windows Vista Enterprise* Windows Vista Home Basic* Windows Vista Home Premium* Windows Vista Ultimate* Windows Server 2008 Standard* Windows Server 2008 Enterprise* Windows Server 2008 R2 Standard Windows Server 2008 R2 Enterprise Windows 7 Home Basic* Windows 7 Home Premium* Windows 7 Professional* Windows 7 Enterprise* Windows 7 Ultimate* Windows 8* Windows 8 Pro* Windows 8 Enterprise* Windows Server 2012 Datacenter Windows Server 2012 Standard *Supports 32-bit (x86) or 64-bit (x64) Environments

continued

Konica Minolta bizhub C364e/C284e/C224e

Specification & Installation Guide



Print Drivers continued

Page Description Language	Print Driver	Supported Operating Systems
PostScript 3 Emulation	Konica Minolta PostScript 3 Driver	Windows XP Home Edition (Service Pack 1 or later) Windows XP Professional (Service Pack 1 or later) Windows Server 2003, Standard Edition (Service Pack 1 or later) Windows Server 2003, Enterprise Edition (Service Pack 1 or later) Windows Server 2003 R2, Standard Edition Windows Server 2003 R2, Enterprise Edition Windows XP Professional x64 Edition Windows Server 2003 Standard x64 Edition Windows Server 2003, Enterprise x64 Edition Windows Server 2003 R2, Standard x64 Edition Windows Server 2003 R2, Enterprise x64 Edition Windows Vista Business* Windows Vista Enterprise* Windows Vista Home Basic* Windows Vista Home Premium* Windows Vista Ultimate* Windows Server 2008 Standard* Windows Server 2008 Enterprise* Windows Server 2008 R2 Standard Windows Server 2008 R2 Enterprise Windows 7 Home Basic* Windows 7 Home Premium* Windows 7 Professional* Windows 7 Enterprise* Windows 7 Ultimate* Windows 8* Windows 8 Pro* Windows 8 Enterprise* Windows Server 2012 Datacenter Windows Server 2012 Standard *Supports 32-bit (x86) or 64-bit (x64) Environments

Page Description Language	Print Driver	Supported Operating Systems
XPS Driver Emulation	Konica Minolta XPS Driver	Windows Vista Business* Windows Vista Enterprise* Windows Vista Home Basic* Windows Vista Home Premium* Windows Vista Ultimate* Windows Server 2008 Standard* Windows Server 2008 Enterprise* Windows Server 2008 R2 Standard Windows Server 2008 R2 Enterprise Windows 7 Home Basic* Windows 7 Home Premium* Windows 7 Professional* Windows 7 Enterprise* Windows 7 Ultimate Windows 8* Windows 8 Pro* Windows 8 Enterprise* Windows Server 2012 Datacenter Windows Server 2012 Standard *Supports 32-bit (x86) or 64-bit (x64) Environments
PostScript PPD Driver	Konica Minolta PostScript PPD Driver	Mac OS 9.2 or later Mac OSX 10.2.8, 10.3, 10.4, 10.5, 10.6, 10.7, 10.8

continued

Konica Minolta bizhub C364e/C284e/C224e

Specification & Installation Guide



KONICA MINOLTA

Print Drivers continued

Page Description Language	Print Driver	Supported Operating Systems
Fax Driver	Konica Minolta	Windows XP Home Edition (Service Pack 1 or later) Windows XP Professional (Service Pack 1 or later) Windows Server 2003, Standard Edition (Service Pack 1 or later) Windows Server 2003, Enterprise Edition (Service Pack 1 or later) Windows Server 2003 R2, Standard Edition Windows Server 2003 R2, Enterprise Edition Windows XP Professional x64 Edition Windows Server 2003 Standard x64 Edition Windows Server 2003, Enterprise x64 Edition Windows Server 2003 R2, Standard x64 Edition Windows Server 2003 R2, Enterprise x64 Edition Windows Vista Business* Windows Vista Enterprise* Windows Vista Home Basic* Windows Vista Home Premium* Windows Vista Ultimate* Windows Server 2008 Standard* Windows Server 2008 Enterprise* Windows Server 2008 R2 Standard Windows Server 2008 R2 Enterprise Windows 7 Home Basic* Windows 7 Home Premium* Windows 7 Professional* Windows 7 Enterprise* Windows 7 Ultimate* Windows 8* Windows 8 Pro* Windows 8 Enterprise* Windows Server 2012 Datacenter Windows Server 2012 Standard *Supports 32-bit (x86) or 64-bit (x64) Environments

Print Specifications

Item	Specifications
Model	Built-in print system
Power Supply	Common with the main body
CPU	800 MHz (shared with copier)
RAM	2 GB
Hard Disk	250 GB (shared with copier)
Interface	Standard Ethernet (10Base-T, 100Base-TX or 1000Base-T) Standard USB 2.0, USB 1.1, USB Host
Frame Type	Ethernet 802.2 Ethernet 802.3 Ethernet II Ethernet SNAP
Supported Protocols	TCP/IP (IPv4/IPv6), BOOTP, ARP, ICMP, DHCP, DHCPv6, AutoIP, SLP, SNMP, FTP, LPR/LPD, RAW Socket, SMB over TCIP/IP, IPP, HTTP, POP, SMTP, LDAP, NTP, SSL, IPX, AppleTalk, Bonjour, NetBEUI, WebDAV, DP-WS, S/MIME, IPsec, DNS, Dynamic DNS, LLMNR, LLTD, SSDP, SOAP
Print Speed Color/BW	C364e: 36 ppm (Letter \square /Simplex and Duplex) C284e: 28 ppm (Letter \square /Simplex and Duplex) C224e: 22 ppm (Letter \square /Simplex and Duplex)
First Print Time	C364e: Full Color: 6.9 sec. or less B&W: 5.3 sec. or less C284e: Full Color: 7.7 sec. or less B&W: 5.9 sec. or less C224e: Full Color: 8.3 sec. or less B&W: 6.9 sec. or less
Operating Environment Conditions	50° to 86° F, 15-85% RH
Resolution	600 x 600 dpi (1800 equivalent x 600 dpi), 1200 x 1200 dpi
Data Processing	600 x 600 dpi (Printing and faxing operations) 400 x 400 dpi (faxing operations) 200 x 200 dpi (faxing operations)
Supported Paper Sizes	Width: 4" to 12.25" Length: 6" to 18"
Printer Fonts	PCL Resident Fonts 80 Roman fonts PS3 Emulation resident Fonts: 137 Roman Type 1 fonts
Compatible Computers	IBM PC or compatible and Macintosh (Power PC or Intel Processor)

continued

Konica Minolta bizhub C364e/C284e/C224e

Specification & Installation Guide



Print Specifications continued

Item	Specifications
Supported Operating Systems	<p>Server Windows Server 2003, Server 2003 R2, Server 2008, Windows Server 2003 x64, Server 2003 R2 x64, Server 2008 x64, Server 2008 R2 x64, Server 2012 x64</p> <p>Client Windows XP, Vista, 7/8, Windows XP x64, Vista x64, 7 x64, 8 x64, Windows Server 2003, Server 2003 R2, Server 2008, Windows Server 2003 x64, Server 2003 R2 x64, Server 2008 x64; Mac OS 9.2, OS X 10.2, 10.3, 10.4 PowerPC version, OS X 10.5 PowerPC, Intel ver., OS X 10.6, 10.7, 10.8 Intel ver.; Red Hat Enterprise Linux</p>
Network	Ethernet (TCP/IP)
Web Browser*	<p>Windows XP/Vista/7/8/Server 2003/Server 2008/Server 2008 R2/Server 2012:</p> <ul style="list-style-type: none"> • Microsoft Internet Explorer 6/7/8/9/10 • Mozilla Firefox 3.5 or later <p>Mac OS 9.x/Mac OS 10.x:</p> <ul style="list-style-type: none"> • Mozilla Firefox 1.0 or later • Mozilla Firefox 3.5 or later <p>Linux:</p> <ul style="list-style-type: none"> • Mozilla Firefox 3.5 or later <p>*JavaScript and cookies must be enabled on your web browser.</p>
Flash Player	<p>Adobe® Flash® Player</p> <ul style="list-style-type: none"> • Plug-in Version 9.0 or later is required to select Flash-based display or use the DATA Management Utility (font/macro's data management)

Scanning

Type	Full-Color Scanner
Scanning Size	11" x 17" to 5.5" x 8.5
Scanning Resolution	<p>Push Scanning: 600/400/300/200 dpi</p> <p>Pull Scanning: 600/400/300/200/100 dpi</p>
Scanning Speed (Color/B&W)	<p>DF-701:† Duplex: 160 opm (300 dpi) 110 opm (600 dpi)</p> <p>Simplex: 80 opm (300 dpi) 55 opm (600 dpi)</p> <p>DF-624:† Duplex: 37 opm (300 dpi) 26 opm (600 dpi)</p> <p>Simplex: 80 opm (300 dpi) 55 opm (600 dpi)</p>
Main Function	Scan-to-Email, Scan-to-User Box (HDD), Scan-to-FTP, Scan-to-USB, Scan-to-SMB (Desktop Folder), Scan-to-Me, Scan-to-Home, Scan-to-Scan Server, Network Twain (via Ethernet TCP/IP), Scan-to-WebDAV, WS-Scan
Interface	10Base-T/100Base-TX/1000Base-T
Protocol	TCP/IP (FTP, SMB, SMTP)
Support OS	Windows XP, Windows Vista, Windows 7, Windows 8, Windows Server 2003, Windows Server 2008, Windows Server 2008 R2, Windows Server 2012
Output Format	Single TIFF, Multi TIFF, JPEG, PDF, Compact PDF, XPS, Compact XPS TIFF (MH, MMR), PDF (MH, MMR, JPEG), JPEG, Outline PDF, PPTX, Searchable PDF, PDF/A, Linearized PDF
Driver	TWAIN (XP/XP 64-bit/Vista/Vista 64-bit/7/7 64-bit/8/8 64-bit), TWAIN Driver, HDD TWAIN Driver
Address Setting	LDAP, Import/Export address from PageScope Web Connection
Authentication	SMTP Authentication, Network User Authentication (Active Directory, Novell, NDS, NTLM ver. 1, NTLM ver. 2, LDAP)

†Text and image scanning speeds vary depending on the type of document.

PageScope Software

Network & Device Management

PageScope Data Administrator
Driver Packaging Utility
HDD BackUp Utility
Log Management Utility*

User Tools

PageScope Direct Print
PageScope Box Operator
PageScope Print Status Notifier
Copy Protection Utility
Print Utility for Unix
PageScope Web Connection

Management Tools

bizhub vCare

Optional Software

PageScope Enterprise Suite
– PageScope Account Manager
– PageScope Authentication Manager
– PageScope My Print Manager
– PageScope My Panel Manager
– PageScope Net Care Device Manager (Standard)

NOTE: Users interested in PageScope EMS Plug-ins should consult with their local Konica Minolta office.

Security

Because information assets are critical, a company needs to effectively protect against the many security risks it faces.

- 1) Prevent Leaks of proprietary, confidential or personal information
- 2) Prevent unauthorized use of equipment
- 3) Effective data encryption
- 4) Protect data from being altered, duplicated or deleted
- 5) Prevent unauthorized access to data via the Internet
- 6) Protect against cyber attacks
- 7) Manage log history

Protective Functions:

- HDD Sanitizing — Deletes Graphic Data (when disposing of machine)
- Job Erase — Deletes Graphic Data (after each job)
- Lock Job (when printing confidential documents)
- Protect data by requiring department name and 8-digit password
- Account Track
- HDD Lock
- Prevent Unauthorized Use
- Operation Log with 2,000-event memory
- HDD Encryption
- PDF Scan Encryption
- Protective Functions
- Copy Protection
- Network Authentication
- Single Sign-on Authentication
- SMTP Authentication for Email
- SSL/TSL Compatibility for PS Web Connection, PS Data Administrator and LDAP Server
- Scan Data Encryption (TCP/socket SSL Compatibility)
- LDAP Authentication
- Box Operator Data Encryption
- Verification of Box Data Receipt
- IP Address Filtering
- IP v6
- Encrypted Network Password Printing
- Scan-to-USB Memory with User Authentication
- Print-from-USB Memory with User Authentication
- S/MIME/Encryption
- FIPS 140-2 Compliance
- IEEE 2600.1 Security Ready

Optional Protective Functions:

- SC-508 Copy Guard Kit
- LK-102 v3 Enhanced PDF Scan Encryption
- AU-102 Biometric Authentication Unit
- AU-201H HID Proximity Card Reader
- AU-202H HID iClass Card Reader
- AU-201H Magnetic Stripe Card Reader
- AU-211P* CAC/PIV Solution with Certificate

*Not available at time of launch.

Konica Minolta bizhub C364e/C284e/C224e

Specification & Installation Guide



Paper Considerations

Paper Size Conversion Chart

Paper	Letter	Letter R	Legal	Tabloid	Statement	Statement R
Measurement	8.5" x 11"	11" x 8.5"	8.5" x 14"	11" x 17"	5.5" x 8.5"	8.5" x 5.5"

Paper Weight Conversion Chart

gsm	Bond	Offset	Cover	Tag	Index	Point	Bristol	Caliper	
								inches	mm
60.20	16	40	22	37	33	3.2	27.4	0.0032	0.081
67.72	18	45	24	41	37	3.6	30.9	0.0036	0.092
75.20	20	50	28	46	42	3.8	34.3	0.0038	0.097
90.30	24	60	33	56	50	4.8	41.2	0.0048	0.120
105.35	28	70	39	64	58	5.8	48.1	0.0058	0.147
109.11	29	73	40	62	60	6.0	49.8	0.0060	0.152
116.63	31	81	45	73	66	6.1	53.2	0.0061	0.155
131.68	35	90	48	80	74	6.2	60.1	0.0062	0.157
135.45	36	90	50	82	75	6.8	61.8	0.0068	0.173
146.73	39	100	54	90	81	7.2	67.0	0.0072	0.183
150.50	40	100	56	93	83	7.3	68.7	0.0073	0.185
161.78	43	110	60	100	90	7.4	73.8	0.0074	0.188
165.55	44	110	61	102	92	7.6	75.5	0.0076	0.193
176.83	47	120	65	108	97	8.0	80.7	0.0078	0.198
199.41	53	135	74	122	110	9.0	91.0	0.0085	0.216
203.17	54	137	75	125	113	9.0	92.7	0.0090	0.229
218.22	58	146	80	134	120	9.5	99.6	0.0092	0.234
244.56	65	165	90	150	135	10.0	111.6	0.0095	0.241
252.08	67	170	93	156	140	10.5	115.1	0.0100	0.250
270.90	72	183	100	166	150	11.0	123.7	0.0110	0.289
285.95	76	192	105	175	158	13.0	130.5	0.0130	0.330
308.52	82	208	114	189	170	14.0	140.8	0.0140	0.356
312.00	87	220	120	200	180	15.0	142.4	0.0150	0.380
385.06	105	267	146	244	220	18.0	175.8	0.0175	0.445

Paper Type Specifications

Thin Paper

Thin Paper is paper weighing between 14 lb. to 15.5 lb. bond. It can be fed via any paper tray, except the bypass tray.

Normal (Plain Paper)

The Normal paper is used for copying in general and is called "PPC paper." The normal paper is usually not a recycled paper. Specify [Normal] to the tray to which the normal paper or the recycled paper is loaded for copying.

Recycled Paper

Recycled Paper is identified as recycled paper along with a designation as to the percentage of the paper that is actually made from recycled materials. Generally speaking, these devices will support recycled paper weighing between 16 lb. to 24 lb. bond.

Thick Paper 1

Thick Paper 1 is paper weighing between 24.25 to 32 lb. bond. It can be fed via any paper tray.

Thick Paper 1+

Thick Paper 1+ is paper weighing between 32.25 to 41.75 lb. bond. It can be fed via any paper tray.

Thick Paper 2

Thick Paper 2 is paper weighing between 42 to 55.5 lb. bond. It can be fed via any paper tray.

Thick Paper 3

Thick Paper 3 is paper weighing between 55.75 to 68 lb. bond. It can be fed via any paper tray.

Thick Paper 4

Thick Paper 4 is paper weighing between 68.25 to 79.75 lb. bond. It can be fed via the bypass tray.

Special Paper

A thin or other specialty type paper that falls within the paper weight specification and appears on the Recommended Paper Stock List.

OHP

Specify [OHP] to a tray to which transparent films are loaded. It can be fed only via the bypass tray (20 sheets or less). Black and white printing supported only.

Envelopes

Specify [Envelope] for bypass tray.

Postcards

A Postcard is defined as a rectangular piece of the thick paper or thin cardboard. This product series supports 4" x 6" size postcards. Postcards are fed only via the Bypass Tray.

Tab Dividers

A stiff sheet with divider tabs. Tab Divider sheets can only be fed (long edge only) via the Bypass Tray.

Banner Paper

An 11.75" x 47.25" paper that is fed via the Bypass Tray to create banners.

Konica Minolta bizhub C364e/C284e/C224e

Specification & Installation Guide



Recommended Paper Stocks

Plain Paper – Color

Class.	Weight	Brand of Paper	Size
Plain Paper	20 lb. Bond (75 gr)	Domtar Recycled Copy (30% Post Consumer)	8.5" x 11"
Plain Paper	22 lb. Bond (80 gr)	Konica Minolta CF Paper	8.5" X 11"
Plain Paper	22 lb. Bond (80 gr)	Konica Minolta CF Paper	11" X 17"
Plain Paper	22 lb. Bond (80 gr)	Konica Minolta CF Paper	12" X 18"
Plain Paper	24 lb. Bond (89 gr)	SMART Carnival Stellar White	8.5" x 11"
Plain Paper	24 lb. Bond (89 gr)	SMART Carnival White	8.5" x 11"
Plain Paper	24 lb. Bond (90 gr)	SMART Synergy Bond 25% Cotton	8.5" x 11"
Plain Paper	24 lb. Bond (90 gr)	Domtar Microprint Laser	8.5" x 11"
Plain Paper	24 lb. Bond (90 gr)	Mohawk Color Copy 98 Bright White	8.5" x 11"
Thick 1	28 lb. Bond (105 gr)	Konica Minolta CF Paper	8.5" X 11"
Thick 1	28 lb. Bond (105 gr)	Konica Minolta CF Paper	11" X 17"
Thick 1	28 lb. Bond (105 gr)	Konica Minolta CF Paper	12" X 18"
Thick 1	28 lb. Bond (105 gr)	Domtar Microprint Color Copy	8.5" x 11"
Thick 1	32 lb. Bond (120 gr)	Hammermill Color Copy	8.5" X 11"
Thick 1	32 lb. Bond (120 gr)	Hammermill Color Copy Paper – Photo White	8.5" x 11"
Thick 2	60 lb. Cover (163 gr)	Hammermill Color Copy	8.5" X 11"
Thick 3	80 lb. Cover (216 gr)	Hammermill Color Copy	8.5" X 11"
Thick 4	100 lb. Cover (271 gr)	Hammermill Color Copy	8.5" X 11"

Plain Paper – B/W

Plain Paper	20 lb. Bond (75 gr)	Hammermill Tidal MP	8.5" X 11"
-------------	---------------------	---------------------	------------

Single-Sided Glossy

Thick 3	10pt Cover (219 gr)	SMART Kromekote Laser High Gloss Coated One Side 10 pt Cover	8.5" x 11"
Thick 3	12pt Cover (247 gr)	SMART Kromekote Laser High Gloss Coated One Side 12 pt Cover	8.5" x 11"

Double-Sided Glossy

Thick 1	32 lb. Bond (120 gr)	Mohawk Color Copy Gloss Pure White	8.5" x 11"
Thick 1	80 lb. Text (118 gr)	Sappi Opus Gloss	8.5" x 11"
Thick 1	90 lb. Text (133 gr)	SMART Kromekote Laser High Gloss Coated Two Sides*	8.5" x 11"
Thick 3	80 lb. Cover (216 gr)	Mohawk Color Copy Gloss Pure White	8.5" x 11"
Thick 3	80 lb. Cover (216 gr)	Sappi Opus Gloss Cover	8.5" x 11"

Double-Sided Glossy continued

Class.	Weight	Brand of Paper	Size
Thick 3	80 lb. Cover (216 gr)	Domtar Microprint Coated Laser Gloss Cover	8.5" x 11"
Thick 3	10 pt Cover (234 gr)	SMART Kromekote Laser High Gloss Coated Two Sides 10 pt Cover	8.5" x 11"
Thick 3	90 lb. Cover (237 gr)	SMART Kromekote® Plus C2S Cover	8.5" x 11"
Thick 4	100 lb. Cover (270 gr)	Mohawk Color Copy Gloss Pure White 100C	8.5" x 11"

Cover Stock

Thick 2	60 lb. Cover (163 gr)	Domtar Microprint Color Copy Cover	8.5" x 11"
Thick 2	65 lb. Cover (176 gr)	Domtar Microprint Color Copy Cover	8.5" x 11"
Thick 3	80 lb. Cover (216 gr)	Domtar Microprint Coated Laser Matte Cover	8.5" x 11"
Thick 3	80 lb. Cover (216 gr)	Domtar Microprint Color Copy Cover	8.5" x 11"
Thick 3	80 lb. Cover (216 gr)	SMART Carnival White Cover	8.5" x 11"
Thick 3	140 lb. Index (255 gr)	Wausau Exact Index	8.5" x 11"
Thick 3	80 lb. Cover (216 gr)	Mohawk Color Copy 98 Bright White	8.5" x 11"
Thick 4	100 lb. Cover (270 gr)	Mohawk Color Copy 98 Bright White	8.5" x 11"

Labels

Avery Dennison 5889 Postcard	8.5" x 11"
Avery Dennison 6870 (30 labels per sheet)	8.5" x 11"
Avery Dennison 6873 (8 labels per sheet)	8.5" x 11"
Avery Dennison 6876 (2 labels per sheet)	8.5" x 11"
Avery 6878 4-UP labels for Color Laser	8.5" x 11"

Envelopes

Envelopes 24 lb.	Preservation Wove 5789 #6 3/4	3.85" x 6.5" (98 x 165 mm)
------------------	-------------------------------	----------------------------

Tab Dividers

Avery Dennison 20406 (long edge only)	8.5" x 11"
---------------------------------------	------------

Specialty Paper

Thick 2	—	TECHNI-Print 9721PO* T-shirt Transfer Paper**	8.5" x 11"
---------	---	-----------------------------------------------	------------

Transparency

OHP Sheets	—	3M-PP2500	8.5" x 11"
------------	---	-----------	------------

Banner Paper

Banner Mode/Thick 1	100 lb. Text (180 gr)	Konica Minolta Banner Paper	11.75" x 47.25"
---------------------	-----------------------	-----------------------------	-----------------

* Paper cannot be used in a high humidity environment.

** T-Shirt Transfer Paper: The C364e/C284e/C224e Series should not be used solely for T-shirt transfer applications. T-Shirt transfer paper should be used on a limited basis, not to exceed a 250-sheet per run maximum. If a misfeed should occur, clear it immediately (due to the odor) and then run 15-25 sheets of regular plain paper (20 lb.) through the device to clean the fusing rollers. T-Shirt Transfer paper cannot be used in high humidity environments.

How to Build a System for the bizhub C364e/C284e/C224e Digital Printer/Copier/Scanner/Fax (from start to finish)

- Step 1: Base Unit**
- C364e/C284e/C224e Digital Color Printer/Copier/Scanner
Includes PS, PCL & XPS Controller, 2 GB Standard Memory, Duplex Unit, 250 GB HDD, USB Interfaces for Scan-to-USB Thumb Drive/Print-from-USB Thumb Drive, USB Local Printing, Optional Authentication Device Connection, Service USB Firmware Updates, CMYK Developer Units, Color Drum Units and Black Drum Unit
- Step 2: Document Handling Options (Required)**
Select one of the following:
- OC-511 Original Cover
 - DF-624 Reversing Automatic Document Feeder
 - DF-701 Single Pass Dual Scan Document Feeder
- Step 3: Paper Supply/Cabinet Options (Required)**
Select one of the following:
- PC-410 Large Capacity Cassette (2,500 sheets - Letter crosswise only)
 - PC-210 2-way Paper Feed Cassette (Two 500-sheet Universal Cassettes)
 - PC-110 Paper Feed Cassette (One 500-sheet Universal Cassette; Includes 1 storage drawer)
 - DK-510 Copy Desk (Storage Drawer Only)
- Step 4: Output Options**
- JS-506 Job Separator Tray
 - FS-534 Floor Finisher (50-sheet stapling)
 - PK-520 Punch Kit (for FS-534)
 - SD-511 Saddle Stitcher Kit (for FS-534)
 - FS-533 Inner Finisher (50-sheet stapling)
 - PK-519 Punch Kit (for FS-533)
- Step 5: Analog Fax Options**
- FK-511 Fax Kit (First Fax Line)
 - FK-511 Fax Kit (Second Fax Line)
 - SP-501 Stamp Unit (Installed in optional Document Feeder)
 - Spare TX Marker Stamp 2
- Step 6: Controller Options**
- Standard Controller (PCL/PS/XPS)
 - IC-414 Fiery Image Controller for C364e/C284e
 - VI-506 Interface Kit (Required for IC-414)
- Step 7: Additional Options**
- AU-102 Biometric Authentication Unit (Requires WT-506 Working Table)
 - AU-201H HID Proximity Card Authentication Unit (Requires WT-506 Working Table or Mk-735 Mount Kit)
 - AU-202H HID iClass Card Authentication Unit (Requires WT-506 Working Table or Mk-735 Mount Kit)
 - AU-204H Magnetic Stripe Card Reader (Requires WT-506 Working Table)
 - AU-211P CAC/PIV Solution* (Requires WT-506 Working Table)
 - EK-606 USB Connection Kit (Adds USB 2.0 for External Keyboard and/or Voice Guidance)
 - EK-607 USB Connection Kit (Adds USB 2.0 for External Keyboard, Bluetooth® and/or Voice Guidance)
 - External Keyboard (Requires KH-102)
 - KH-101 10-Key Pad (Hard-key 10 Key-pad)
 - KP-101 10-Key Pad (Hard-key 10 Key-pad)
- LK-101 v3 i-Option License Kit (Web Browser; Requires UK-204)
 - LK-102 v3 i-Option License Kit (Enhanced PDF Encryption, PDF/A (1a/1b) and Linearized PDF support; Requires UK-204)
 - LK-104 v3 i-Option License Kit (Voice Guidance; Requires UK-204)
 - LK-105 v3 i-Option License Kit (Searchable PDF; Requires UK-204)
 - LK-106 i-Option License Kit (Bar Code Font Printing; Requires UK-204)
 - LK-107 i-Option License Kit (Unicode Font Printing; Requires UK-204)
 - LK-108 i-Option License Kit (OCR Font Printing; Requires UK-204)
 - LK-110 i-Option License Kit (iOOXML file conversion, Enhanced Image Data, Combines LK-102 & LK-105 functionality; Requires UK-204)
 - LK-111 i-Option License Kit (ThinPrint Client Support)
 - MK-730 Banner Paper Guide
 - MK-735 Mount Kit (for AU-201H, AU-202H)
 - SC-508 Copy Guard Kit (CopyGuard/ Password Copy Protection; 2 Kits required for DF-701)
 - UK-204 i-Option Memory Upgrade Kit (2 GB) (Required for LK-101 v3, LK-102 v3, LK-104 v3, LK-105 v3, LK-106, LK-107, LK-108, LK-110 and PageScope My Panel; Only one memory upgrade required per MFP)
 - WT-506 Working Table

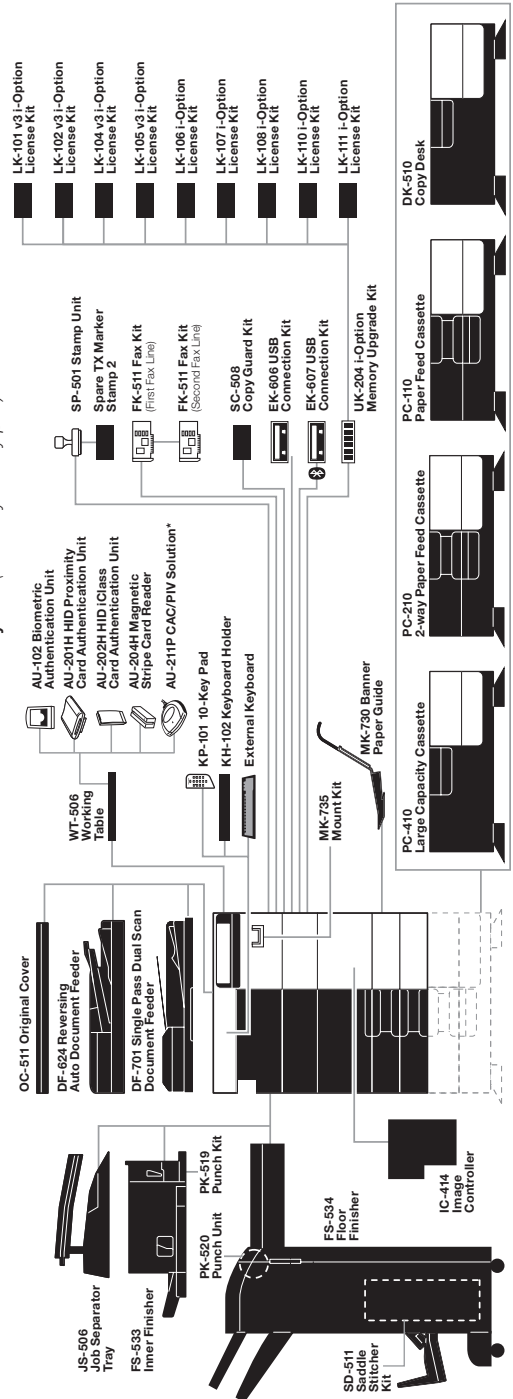

* Anticipated availability Summer 2013.

Konica Minolta bizhub C364e/C284e/C224e

Specification & Installation Guide



Accessory Options for bizhub C364e/C284e/C224e Digital Color Printer/Copier/Scanner/Fax

ACCESSORIES	ITEM NO.	DESCRIPTION	NOTES
BASE UNIT			
C364e	A5C1011	C364e Color Printer/Copier/Scanner	Includes PS, PCL & XPS Controller, 2 GB Standard Memory, Duplex Unit, 250 GB HDD, USB Interfaces for Scan-to-USB Thumb Drive/Print-from-USB Thumb Drive, USB Local Printing, Optional Authentication Device Connection, Service USB Firmware Updates, CMYK Developer Units, Color Drum Units and Black Drum Unit.
C284e	A5C2011	C284e Color Printer/Copier/Scanner	Includes PS, PCL & XPS Controller, 2 GB Standard Memory, Duplex Unit, 250 GB HDD, USB Interfaces for Scan-to-USB Thumb Drive/Print-from-USB Thumb Drive, USB Local Printing, Optional Authentication Device Connection, Service USB Firmware Updates, CMYK Developer Units, Color Drum Units and Black Drum Unit.
C224e	A5C4011	C224e Color Printer/Copier/Scanner	Includes PS, PCL & XPS Controller, 2 GB Standard Memory, Duplex Unit, 250 GB HDD, USB Interfaces for Scan-to-USB Thumb Drive/Print-from-USB Thumb Drive, USB Local Printing, Optional Authentication Device Connection, Service USB Firmware Updates, CMYK Developer Units, Color Drum Units and Black Drum Unit.
DOCUMENT HANDLING OPTION			
OC-511	A3PMWY1	Original Cover	Required if DF-624 or DF-701 is not installed.
DF-624	A3CFWY1	Reversing Automatic Document Feeder	100-Sheet Reversing Automatic Document Feeder; Compatible with bizhub C364e, C364, C284e, C284, C224e, C224.
DF-701	A3CEWY1	Single Pass Dual Scan Document Feeder	100-Sheet Single Pass Dual Scan Document Feeder; Compatible with bizhub C364e, C364, C284e, C284, C224e, C224.
PAPER SUPPLY/CABINET OPTIONS			
PC-410	A2XM013	Large Capacity Cassette	2,500 sheets; Letter-Size (Portrait) Paper only.
PC-210	A2XMWY2	2-way Paper Feed Cabinet	Two 500-sheet Universal Paper Cassettes.
PC-110	A2XMWY1	Paper Feed Cabinet	One 500-sheet Universal Paper Cassette and Storage Drawer.
DK-510	7640017610	Copy Desk	Storage Drawer only.
OUTPUT OPTIONS			
JS-506	A2YVWY1	Job Separator Tray	Separates print, copy and fax jobs; can be installed if finisher is not attached; supports banner printing.
FS-534	A3EPWY1	Floor Finisher	50-sheet staple finisher required to support PK-520 Punch Kit and SD-511 Saddle Stitcher. Supports banner printing. Compatible with bizhub C754, C654, C364e, C364, C284e, C284, C224e, C224, 754, 654.
FS-533	A2YUWY1	Inner Finisher	50-sheet Inner Staple Finisher required to support PK-519 Punch Kit. Supports banner printing. Compatible with bizhub C364e, C364, C284e, C284, C224e, C224.
PK-519	A3EUW11	2/3-Hole Punch Kit for FS-533	2/3-Hole Punch Kit for FS-533 Inner Finisher. Compatible with bizhub C364e, C364, C284e, C284, C224e, C224.
PK-520	A3ETW11	2/3-Hole Punch Kit for FS-534	2/3-Hole Punch Kit for FS-534. Compatible with bizhub C754, C654, C554, C454, C364e, C364, C284e, C284, C224e, C224, 754, 654.
SD-511	A3ERWY1	Saddle Stitcher Kit for FS-534	Provides booklet output for FS-534. Compatible with bizhub C754, C654, C554, C454, C364e, C364, C284e, C284, C224e, C224, 754, 654.
ANALOG FAX OPTIONS			
FK-511	A4MF012	Fax Kit	Supports single line fax capabilities. Add second FK-511 Fax Kit for dual line fax capabilities
SP-501	4614506	Stamp Unit	Installed on RADF. Compatible with bizhub C754, C654, C652DS, C652, C650, C554, C552DS, C552, C550, C454, C452, C451, C450, C364e, C364, C353, C352, C351, C300, C284e, C284, C253, C252, C250, C224e, C224, C203.
Spare Fax Stamp	4614511	Spare TX Marker Stamp 2	Installed on RADF. Compatible with bizhub C754, C654, C652DS, C652, C650, C554, C552DS, C552, C550, C454, C452, C451, C450, C364e, C364, C353, C352, C351, C300, C284e, C284, C253, C252, C250, C224e, C224, C203.
CONTROLLER OPTIONS			
IC-414	A4FRWY2	Fiery Image Controller	Equipped with 160 GB HDD. Requires Fiery Controller Interface Kit VI-506; Compatible with bizhub C754, C654, C364e, C364, C284e, C284.
VI-506	A4MGWY1	Fiery Controller Interface	Interface Kit for IC-414 Fiery Image Controller.

Konica Minolta bizhub C364e/C284e/C224e

Specification & Installation Guide



Accessory Options for bizhub C364e/C284e/C224e Digital Color Printer/Copier/Scanner/Fax

ACCESSORIES	ITEM NO.	DESCRIPTION	NOTES
ADDITIONAL OPTIONS			
AU-102	A0X9WY1	Biometric Authentication Unit	Scans finger vein patterns to enable users to gain access to the device. Requires WT-506 Working Table.
AU-201H	7640005064	HID Proximity Card Authentication Unit	Allows access to the MFP via HID Proximity Cards. Can be mounted internally using optional MK-735 Mount Kit or externally on optional WT-506 Working Table.
AU-202H	7640008394	HID iClass Card Authentication Unit	Allows access to the MFP via HID iClass Cards. Can be mounted internally using optional MK-735 Mount Kit or externally on optional WT-506 Working Table.
AU-204H	7640013468	Magnetic Stripe Card Reader	Allows authorized access to the MFP using Magnetic Stripe Cards. Requires WT-506 Working Table.
AU-211P*	—	CAC/PIV Solution with Certificate	Requires WT-506 Working Table. Contact your local Government Account Manager for information.
EK-606	A4MJWY2	Local USB Interface Kit	Required to connect optional external keyboard and supports Voice Guidance functions available with optional LK-104 v3.
EK-607	A4MKWY2	Local USB Interface Kit	Required to connect optional external keyboard, provides Bluetooth printing support for mobile phone link and supports Voice Guidance functions available with optional LK-104 v3.
LK-101 v3	A0PD01H	i-Option License Kit	Web Browser. Requires UK-204 i-Option Memory Upgrade.
LK-102 v3	A0PD016	i-Option License Kit	Enables 128-bit AES PDF encryption; PDF File and password are encrypted; provides PDF/A (1a/1b) and Linearized PDF file format support. Requires UK-204 i-Option Memory Upgrade.
LK-104 v3	A0PD017	i-Option License Kit	Provides Voice Guidance functionality. Requires UK-204 i-Option Memory Upgrade.
LK-105 v3	A0PD018	i-Option License Kit	Provides Searchable PDF functionality. Requires UK-204 i-Option Memory Upgrade.
LK-106	A0PD019	i-Option License Kit	Provides Bar Code Font printing support. Requires UK-204 i-Option Memory Upgrade.
LK-107	A0PD01F	i-Option License Kit	Provides Unicode Font printing support. Requires UK-204 i-Option Memory Upgrade.
LK-108	A0PD01G	i-Option License Kit	Provides OCR Font printing support. Requires UK-204 i-Option Memory Upgrade.
LK-110	A0PD01J	i-Option License Kit	Provides DOCX, XLSX format file conversion, Fax to searchable PDF, convert print data in box to compact PDF, combines LK-102 (encrypted PDF) & LK-105 (searchable PDF / OCR) functionality. Requires UK-204 i-Option Memory Upgrade.
LK-111	A0PD01G	i-Option License Kit	Provides ThinPrint client support.
MK-730	A4MEWY1	Banner Paper Guide	Enables automatic feeding of banner paper. Up to 10 banner sheets supported.
MK-735	A4NMWY1	Mount Kit	Internal Mount Kit for AU-201H and AU-202H. Required if these card readers are not mounted externally using the WT-506.
External Keyboard	7640006869	External Keyboard	Computer type keyboard for alphanumeric data entry (alternative to the standard QWERTY keyboard available on the MFP's LCD). Requires either EK-606 or EK-607 and KH-102.
KH-102	A4NRWY1	Keyboard Holder	Holds the optional QWERTY keyboard in place on the MFP.
KP-101	A64TWY1	10-Key Pad	Optional 10 Key Pad. Supports Voice Guidance function available with optional LK-104 v3 i-Option License Kit. Affixes to the right-hand side of the control panel.
SC-508	A4MMWY1	Copy Guard Kit (Copy Guard/ Password Copy Protection)	Detects documents with Copy Protect patterns applied. Gives users the option to prevent copying sensitive documents or allows copying when password is entered. Dual Scan models require two SC-508 Security Kits.
UK-204	A4MHWY1	i-Option Memory Upgrade Kit (2 GB)	Memory Upgrade required for optional LK-101 v3, LK-102 v3, LK-104 v3, LK-105 v3, LK-106, LK-107, LK-108, LK-110 and PageScope My Panel. Contents include 2 GB memory upgrade. Only one memory upgrade needed per device.
WT-506	A0W4WY2	Working Table	Required for AU-102 Biometric Unit, AU-204H Magnetic Stripe Card Reader and AU-211P CAC/PIV Solution; required for AU-201H HID Proximity Card Authentication Unit and AU-202H HID iClass Card Authentication Unit if these card readers are not mounted internally using the MK-735.

* Anticipated availability Summer 2013.

Konica Minolta bizhub C364e/C284e/C224e

Specification & Installation Guide



Accessory Options for bizhub C364e/C284e/C224e Digital Color Printer/Copier/Scanner/Fax

CONSUMABLE YIELDS*

CONSUMABLE	ITEM NO.	YIELD
DV512K Developing Unit – Black	A2XN03D	590,000
DV512C Developing Unit – Cyan	A2XN0KD	590,000
DV512M Developing Unit – Magenta	A2XN0ED	590,000
DV512Y Developing Unit – Yellow	A2XN08D	590,000
DR512 Color Drum Unit	A2XN0TD	(C364e) 90,000 (C284e) 75,000 (C224e) 55,000
DR512K Black Drum Unit	A2XN0RD	(C364e) 120,000 (C284e) 120,000 (C224e) 70,000
TN321K Toner – Black	A33K130	27,000
TN321C Toner – Cyan	A33K430	25,000
TN321M Toner – Magenta	A33K330	25,000
TN321Y Toner – Yellow	A33K230	25,000
Waste Toner Box (WX103)	A4NNWY1	40,000
Fusing Unit	A161R71811	590,000
Intermediate Image Transfer Kit	A161R71300	(C364e) 300,000 (C284e) 280,000 (C224e) 225,000
Staples SK-602 (For FS-534, SD-511 and FS-533)	14YK	5,000 x 3 pkg/case

* Based on 20% total coverage.